

## Installation Instructions: Air-Transfer

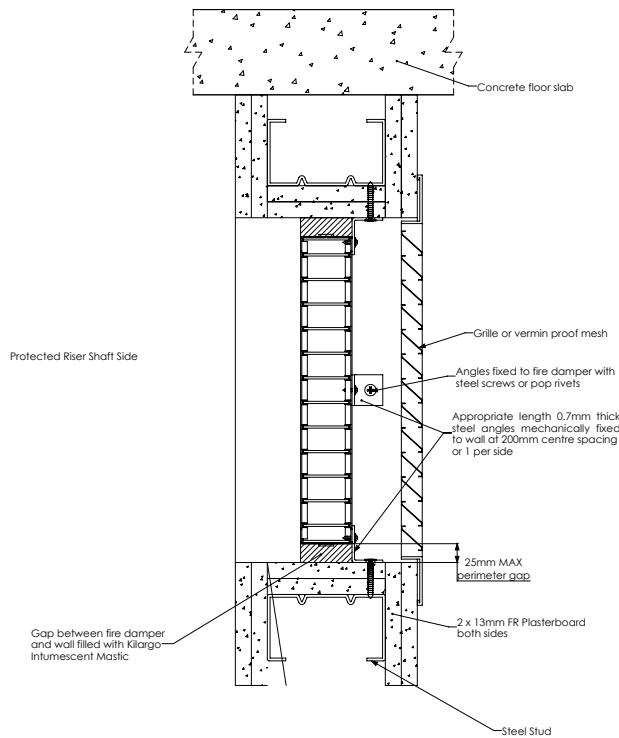

- Step 1** Position damper centrally in penetration aperture as per system drawing with temporary supports or packers.
- Step 2** Fasten mounting angles or brackets to damper with steel self-drilling screws or steel pop rivets and to the building element with appropriate mechanical fixings as per system drawing.
- Step 3** Apply Kilargo Intumescent Mastic (supplied separately) to the gaps between the damper & building element. Ensure fill depth corresponds with those detailed in the system drawing.
- Step 4** Ensure product and certification labels are in a prominent position for easy identification during subsequent maintenance inspections.
- Step 5** Fix grille independently to the building element.

### System Notes

- Grilles, louvres, vermin proof mesh, angles, brackets & fixings are to be supplied by others.
- Grille to be fixed independently to the building element and shall not be fixed to the fire damper.
- Kilargo Intumescent Fire Dampers shall be installed in accordance with this detail, including the use of Kilargo Intumescent Mastic and in accordance with the requirements of AS1682.2.
- Ensure convenient access is provided for visual inspection and cleaning as necessary.
- Fire damper insulation requirements are not required for shaft mounted fire damper as per AS 1668.1:2015 cl 3.2.3.1 (a).
- 2mm Minimum gap allowable between damper and aperture. For gaps between 2-5mm, a fillet of Kilargo Intumescent Mastic shall be applied.

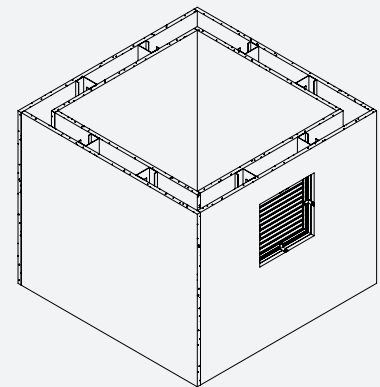

Building element:	Plasterboard 2 x 13
Application:	Cell only installed in riser with grille on one side
Maximum size:	600 x 600 or 0.36 m2
FRL	-/120/-
Test reference No.	FAS200229

**System No. WSW31 (a)**

## Installation Instructions:

### Air-Transfer - Modular

#### U Channel

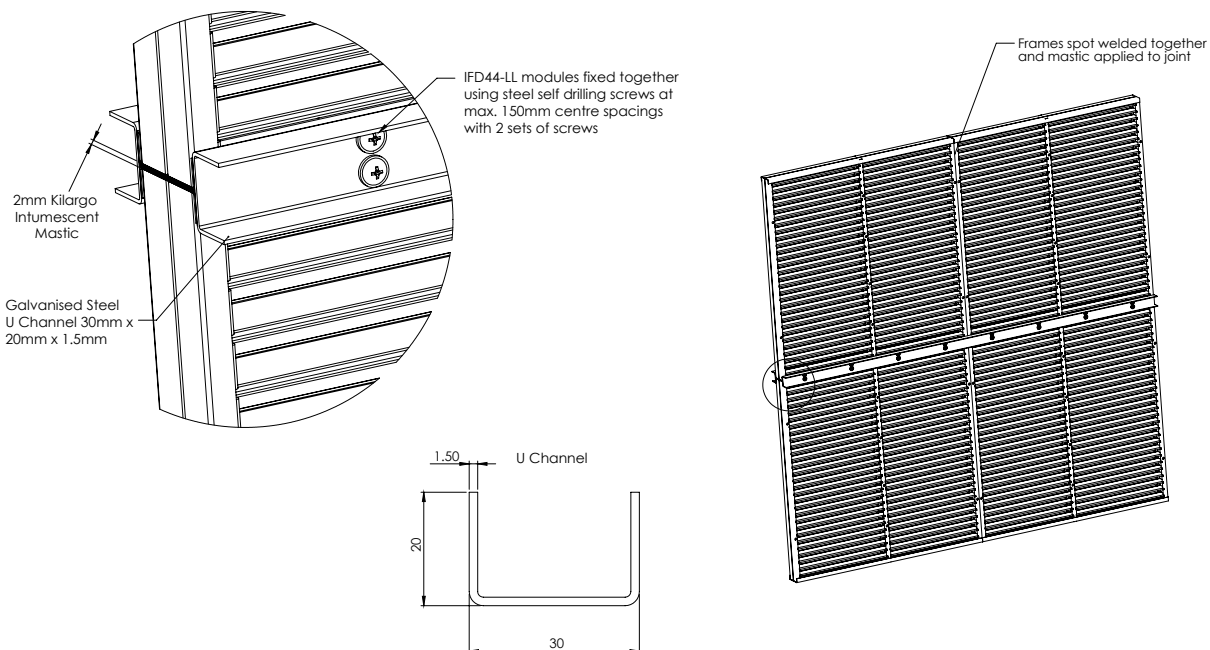

- Step 1** Apply Kilargo Intumescent Mastic to the opposing module
- Step 2** Align and bring modules together and mechanically fix together using U channels and steel self-drilling screws or steel pop rivets with 2 sets of screws at 150mm centres as per the modular system drawing on both sides
- Step 3** Fix modular damper to aperture or casing as shown in the appropriate system drawing and installation instructions

#### System Notes

- Fixings are to be supplied by others.
- Optional flat joining strips supplied at the time of order in lieu of U channel on request for air transfer systems only.

#### Alternative Fixing Methods

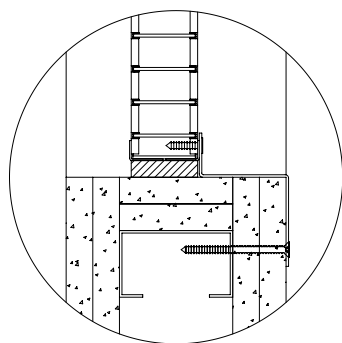

Z Bracket Fixing

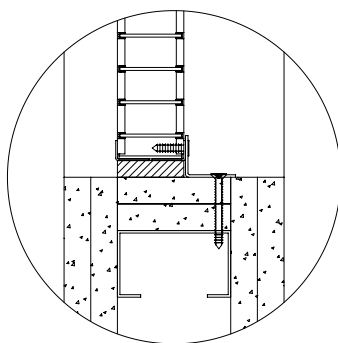

Angle Fixing

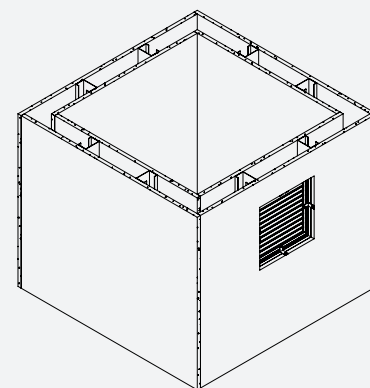

Building element:	Plasterboard 2 x 13
Application:	Cell only installed in riser with grille on one side
Maximum size:	600 x 600 or 0.36 m <sup>2</sup>
FRL	-/120/-
Test reference No.	FAS200229

*Note: To be read in conjunction with system WSW31 (a)*

**System No. WSW31 (b)**