

Installation Instructions:

Ducted

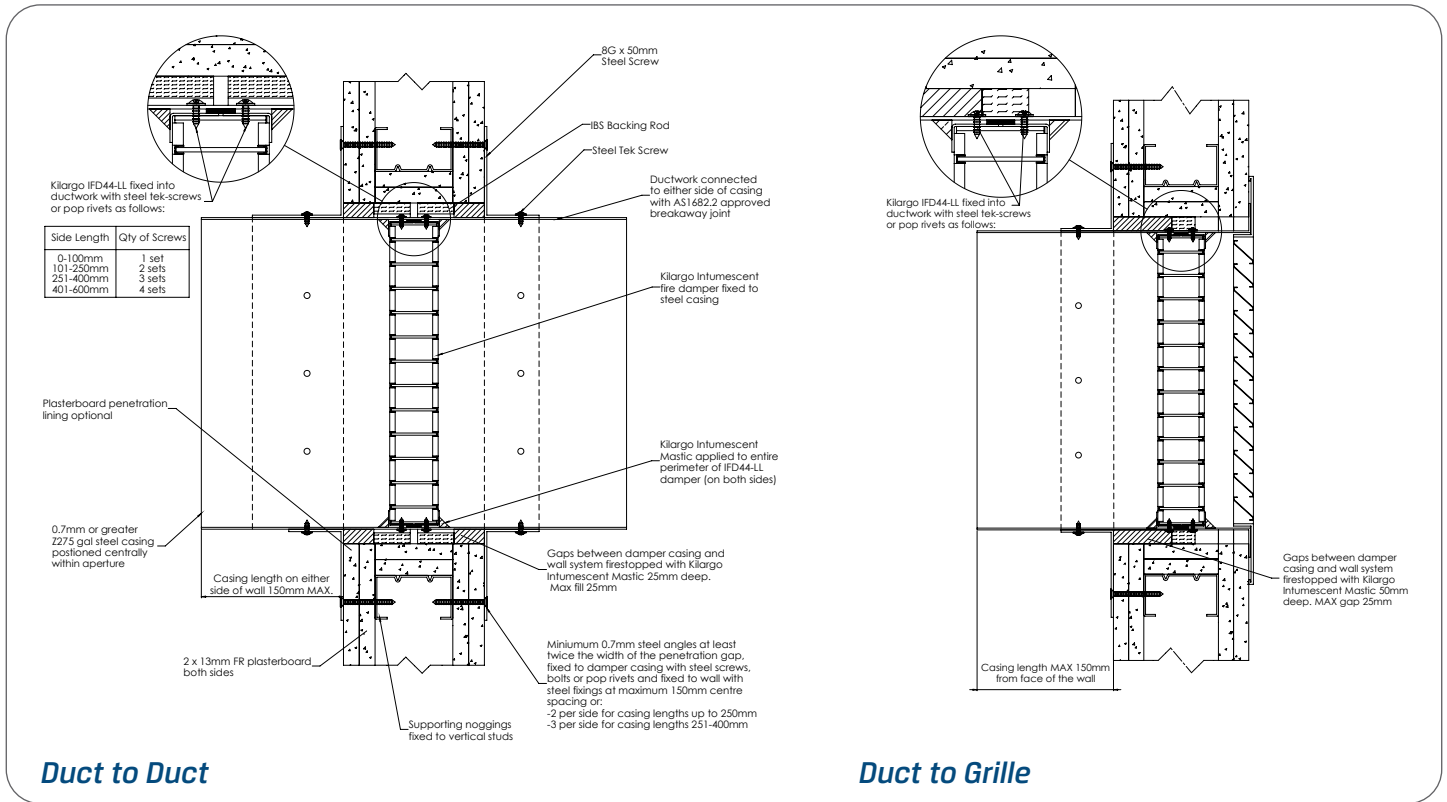

Wall Mounted Systems

- Step 1** Position damper centrally in penetration aperture as per system drawing with IBS Backing Rod and temporary supports or packers.
- Step 2** Apply Kilargo Intumescent Mastic (supplied separately) to the gaps between the damper & building element. Ensure fill depth corresponds with those detailed in the system drawing.
- Step 3** Fasten mounting angles to damper with steel self-drilling screws or steel pop rivets and, if detailed, to the building element with appropriate mechanical fixings as per system drawing.
- Step 4** Ensure product and certification labels are in a prominent position for easy identification during subsequent maintenance inspections.
- Step 5** Connect ductwork to the damper casing with AS 1682.2 compliant breakaway joint.

System Notes

- Grilles, louvres, IBS backing rod & fixings are to be supplied by others.
- Kilargo Intumescent Fire Dampers shall be installed in accordance with this detail, including the use of Kilargo Intumescent Mastic and in accordance with the requirements of AS1682.2.
- Ensure convenient access is provided for visual inspection and cleaning as necessary.
- 2mm Minimum gap allowable between damper and aperture. For gaps between 2-5mm, a fillet of Kilargo Intumescent Mastic shall be applied.

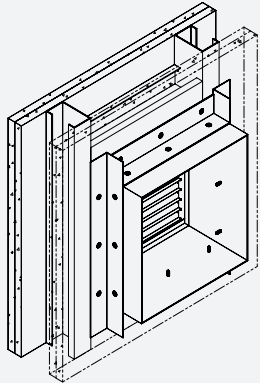

Building element:	FR Plasterboard 2 x 13
Application:	Mounted in casing DD / DG
Maximum size:	1200 x 1200
FRL	-/120/-
Test reference No.	FAS200229

System No. WP9 (a)

Installation Instructions:

Ducted - Modular

U Channel

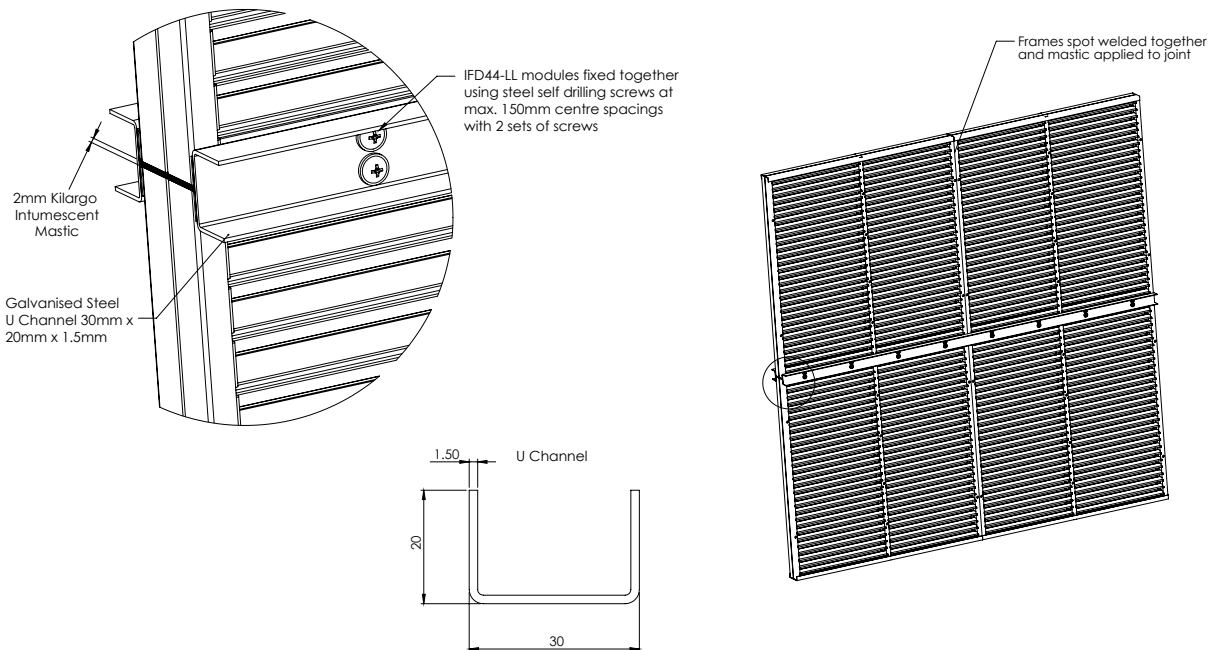

- Step 1** Apply Kilargo Intumescent Mastic to the opposing module.
- Step 2** Align and bring modules together and mechanically fix together using U channels and steel self-drilling screws or steel pop rivets with 2 sets of screws at 150mm centres as per the modular system drawing on both sides.
- Step 3** Fix modular damper to aperture or casing as shown in the appropriate system drawing and installation instructions.

System Notes

- Fixings are to be supplied by others.
- Optional flat joining strips supplied at the time of order in lieu of U channel on request for air transfer systems only.

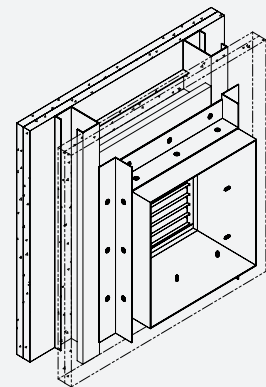

Building element:	FR Plasterboard 2 x 13
Application:	Mounted in casing DD / DG
Maximum size:	1200 x 1200
FRL	-/120/-
Test reference No.	FAS200229

Note: To be read in conjunction with system WP9 (a)

System No. WP9 (b)