

## Installation Instructions:

### Ducted - Retro-fit

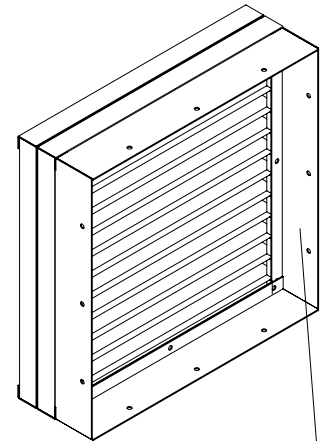
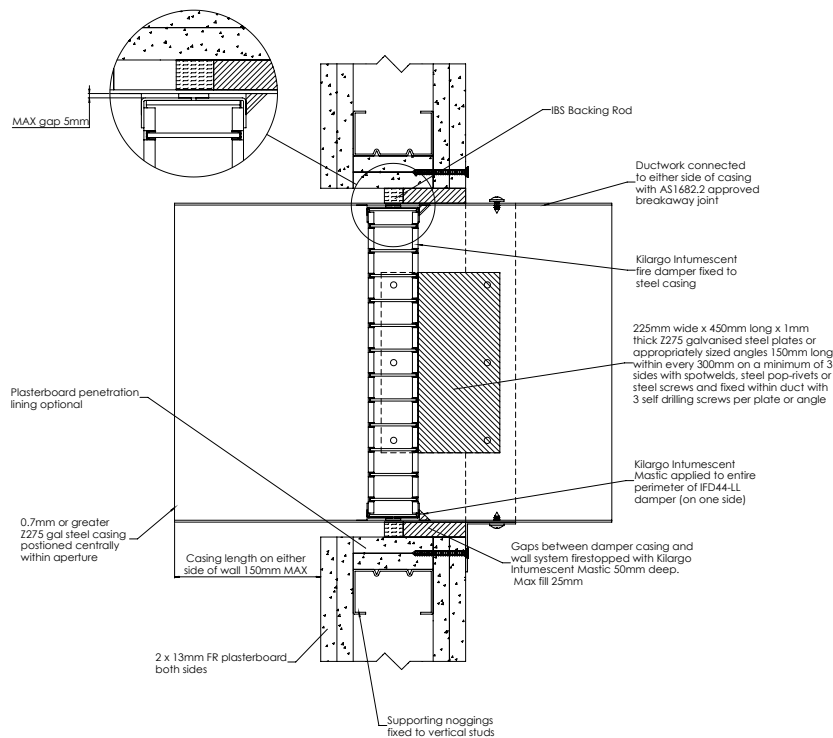

Minimum 15mm x 40mm x 1mm thick full length Z275 galvanised steel angles each side fixed with 3 self drilling screws per angle or within every 50mm

### Retro-fit Option

- Step 1** Fasten mounting angles or plates to damper with steel self-drilling screws or steel pop rivets as per the system drawing.
- Step 2** Position damper inside ductwork within the wall thickness as per system drawing and fix mounting angles or plates with steel self-drilling screws, pop rivets or spot welds.
- Step 3** Apply Kilargo Intumescent Mastic (supplied separately) to the gaps between the damper, damper casing & building element. Ensure fill depth corresponds with those detailed in the system drawing by using IBS backing rod.
- Step 4** Ensure product and certification labels are in a prominent position for easy identification during subsequent maintenance inspections.
- Step 5** Connect ductwork to the damper casing with AS 1682.2 compliant breakaway joint.

### System Notes

- Angles, brackets, plates, IBS backing rod & fixings are to be supplied by others.
- Kilargo Intumescent Fire Dampers shall be installed in accordance with this detail, including the use of Kilargo Intumescent Mastic and in accordance with the requirements of AS1682.2.
- Ensure convenient access is provided for visual inspection and cleaning as necessary.
- 2mm Minimum gap allowable between damper and aperture. For gaps between 2-5mm, a fillet of Kilargo Intumescent Mastic shall be applied.

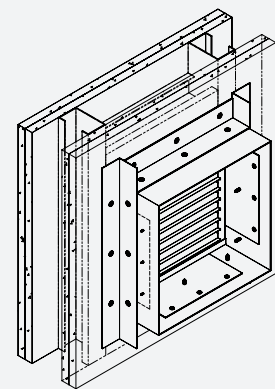

Building element:	Plasterboard 2 x 13
Application:	Retrofit cell only in ductwork
Maximum size:	600 x 600
FRL	-/120/-
Test reference No.	FAS200229

**System No. WRF5**